

Features

- Low Dropout Voltage: 180mV@300mA ($V_o=3.3V$)
- Output Voltage Accuracy within $\pm 2\%$
- Quiescent Current: 65 μ A Typ.
- High PSRR: 70dB@1kHz
- Excellent Line and Load Regulation
- Fast Response
- Current Limiting
- Short Circuit Protection
- Low Temperature Coefficient
- Shutdown Current: 0.5 μ A
- Thermal Shutdown
- Space Saving Package: SOT-23, SOT-89 and SC70
- Pb-Free Package

Applications

- Cordless Phones
- Cellular Phones
- Bluetooth Earphones
- Digital Cameras
- Portable Electronics
- WLANs
- MP3 Players

General Description

The PAM3101 series of positive voltage linear regulators feature low quiescent current (65 μ A Typ.) and low dropout voltage, making them ideal for battery powered applications. Their high PSRR make them useful in applications where AC noise on the input power supply must be suppressed. Space-saving SOT-23, SOT-89 and SC70 packages are attractive for portable and handheld applications. They have both thermal shutdown and current limit features to prevent device failure from extreme operating conditions. They are stable with an output capacitor of 2.2 μ F or greater.

Typical Application

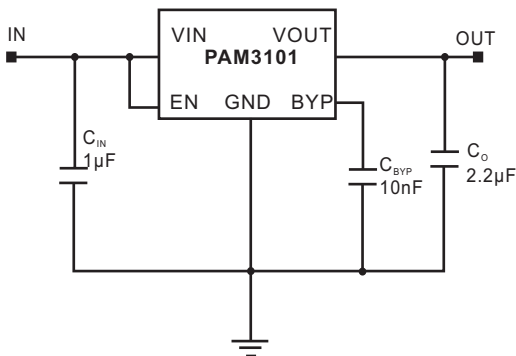

Block Diagram

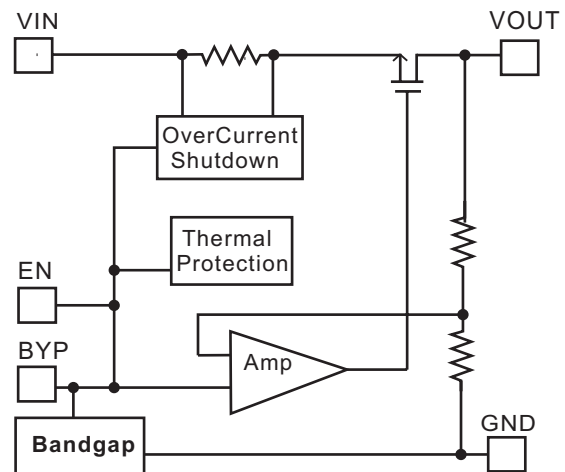

Pin Configuration & Marking Information

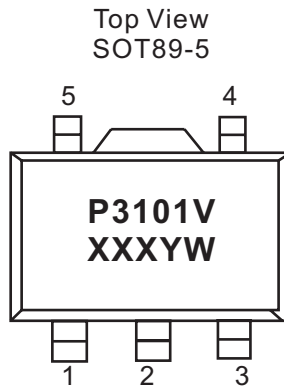
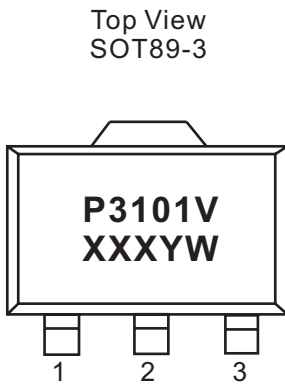
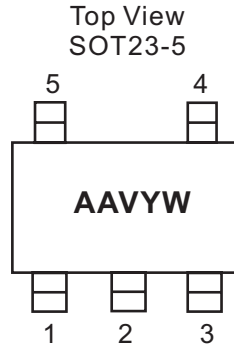
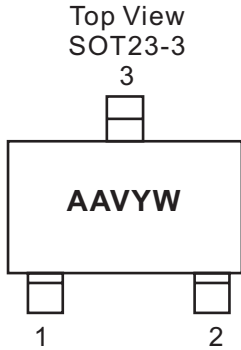

AA: Product Code of PAM3101
 V: Voltage Code
 X: Internal Code
 Y: Year
 W: Week

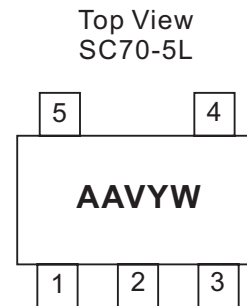
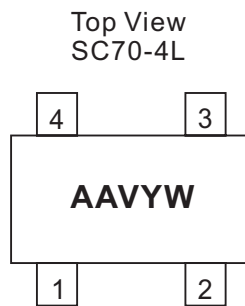
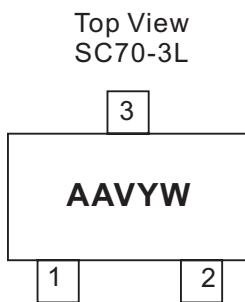



Pin Configuration Available

Pin	1	2	3	4	5
SOT23-3	GND	VOUT	VIN		
	VIN	VOUT	GND		
	VOUT	GND	VIN		
SOT89-3	GND	VIN	VOUT		
	VOUT	GND	VIN		
SOT23-5	VIN	GND	EN	BYP	VOUT
SOT89-5	VOUT	GND	NC	EN	VIN
SC70-3L	VIN	VOUT	GND		
SC70-4L	EN	GND	VOUT	VIN	
SC70-5L	VIN	GND	EN	BYP	VOUT

Pin Descriptions

Name	Function
VIN	Input
GND	Ground
VOUT	Output
EN	Chip Enable (active high)
BYP	Bypass Pin, need a 10nF capacitor connect to GND
NC	No Connection



Absolute Maximum Ratings

These are stress ratings only and functional operation is not implied. Exposure to absolute maximum ratings for prolonged time periods may affect device reliability. All voltages are with respect to ground.

Input Voltage.....6.6V	Lead Soldering Temperature (5sec)..... 300°C
Output Current.....300mA	Storage Temperature.....-65°C to 150°C
Output Pin VoltageGND-0.3V to $V_{IN}+0.3V$	ESD Rating.....Class B

Recommended Operating Conditions

Max. Supply Voltage (for Max. duration of 30 minutes).....6.4V	Junction Temperature.....-40°C to 125°C
	Ambient Temperature.....-40°C to 85°C

Thermal Information

Parameter	Symbol	Package	Maximum	Unit
Thermal Resistance (Junction to Case)	θ_{JC}	SOT-23	130	°C/W
		SOT-89	100	
		SC70	TBD	
Thermal Resistance (Junction to Ambient)	θ_{JA}	SOT-23	250	°C/W
		SOT-89	180	
		SC70	300	
Internal Power Dissipation	P_D	SOT-23	400	mW
		SOT-89	550	
		SC70	300	



Electrical Characteristic

$V_{IN}=V_O+1V$, $T_A=25^\circ C$, $C_{IN}=1\mu F$, $C_O=2.2\mu F$, unless otherwise noted

PARAMETER	SYMBOL	Test Conditions	MIN	TYP	MAX	UNITS	
Input Voltage	V_{IN}		Note 1		5.5	V	
Output Voltage Accuracy	V_O	$I_O=1mA$	-2		2	%	
Output Current	I_O		300		Note 2	mA	
Dropout Voltage	V_{drop}	$I_O=300mA$	$V_O=1.5V$		1150	1400	mV
			$V_O=1.8V$		850	1100	
			$2.5V \leq V_O < 3.3V$		370	450	
			$V_O \geq 3.3V$		180	230	
Ground Current	I_{GND}	$I_O=1mA$ to 300mA		70	90	μA	
Quiescent Current	I_Q	$I_O=0mA$		65	90	μA	
Line Regulation	LNR	$I_O=1mA$, $V_O < 2V$, $V_{IN} = 2.8V$ to $3.8V$	-0.15	0.1	0.15	% / V	
		$I_O=1mA$, $2V \leq V_O < 3.3V$, $V_{IN} = V_O+0.5V$ to V_O+1V	-0.1	0.03	0.1		
		$I_O=1mA$, $V_O \geq 3.3V$, $V_{IN}=V_O+0.5V$ to V_O+1V	-0.4	0.2	0.4		
Load Regulation	LDR	$I_O=1mA$ to 300mA, $V_O \geq 2V$	-2	1	2	%	
		$I_O=1mA$ to 300mA, $V_O < 2V$		30	60	mV	
Temperature Coefficient	T_C	$I_O=1mA$		40		ppm/ $^\circ C$	
Over Temperature Shutdown	OTS	$I_O=1mA$		150		$^\circ C$	
Over Temperature Hysteresis	OTH	$I_O=1mA$		30		$^\circ C$	
Power Supply Ripple Rejection	PSRR	$I_O=100mA$ $C_{BYP}=10nF$ $V_O=3.3V$	$f=100Hz$		70	dB	
			$f=1kHz$		65		
Output Noise	V_n	$f = 10Hz$ to $100kHz$, $C_{BYP}=10nF$		50		μV_{rms}	
EN Input High Threshold	V_{IH}	$V_{IN}=2.5V$ to $5V$	1.5			V	
EN Input Low Threshold	V_{IL}	$V_{IN}=2.5V$ to $5V$			0.3	V	
Shutdown Current	I_{SD}	$V_{EN}=0V$		0.01	1	μA	

Note 1: The minimum input voltage ($V_{IN(MIN)}$) of the PAM3101 is determined by output voltage and dropout voltage. The minimum input voltage is defined as:

$$V_{IN(MIN)} = V_O + V_{drop}$$

Note 2: Output current is limited by P_D , maximum $I_O = P_D / (V_{IN(MAX)} - V_O)$.

Typical Performance Characteristics

$T_A=25^\circ\text{C}$, $V_{EN}=V_{IN}$, $C_{IN}=1\mu\text{F}$, $C_O=2.2\mu\text{F}$, $C_{BYP}=10\text{nF}$, unless otherwise noted.

1. Output Voltage vs Input Voltage

$V_O = 1.8\text{V}$

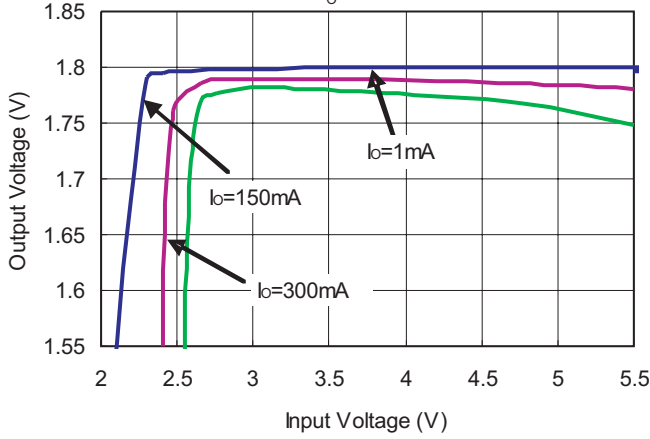

2. Output Voltage vs Output Current

$V_O = 1.8\text{V}$

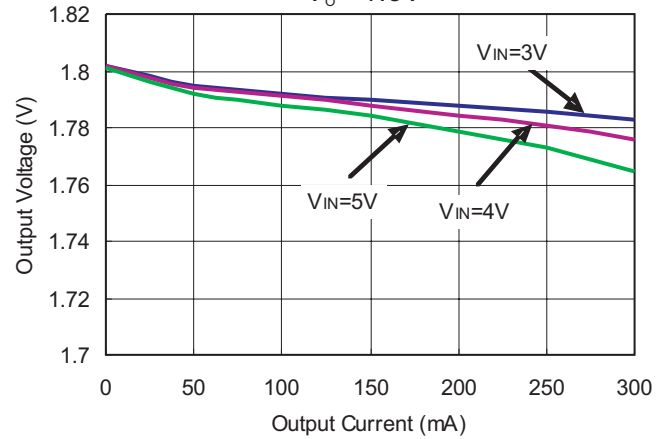

$V_O = 2.5\text{V}$

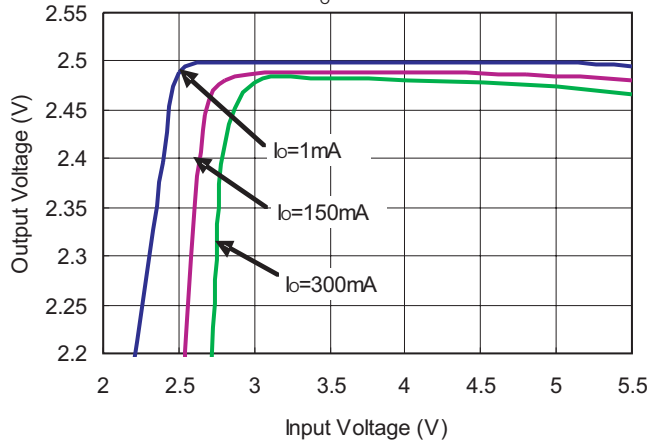

$V_O = 2.5\text{V}$

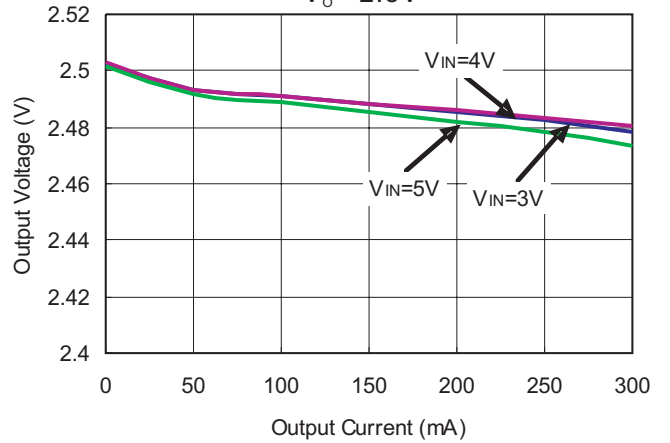

$V_O = 3.3\text{V}$

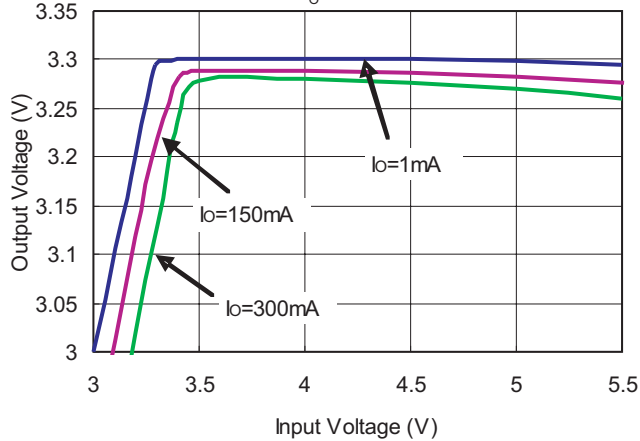

$V_O = 3.3\text{V}$

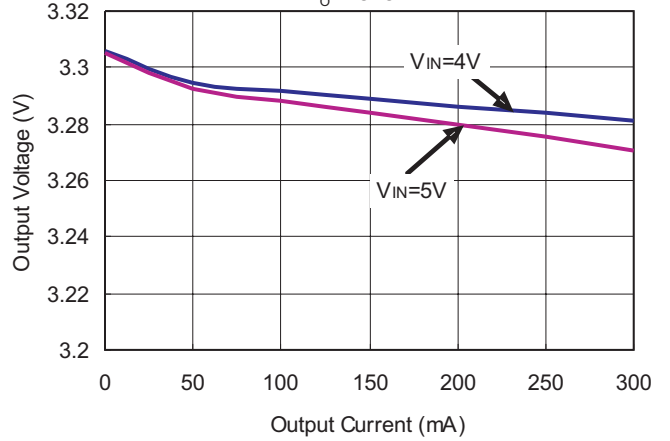

Typical Performance Characteristics

3. Output Voltage vs Temperature

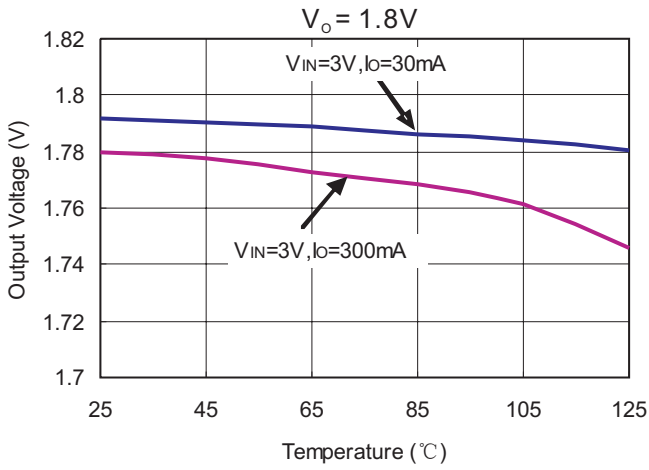

4. Ground Current vs Input Voltage

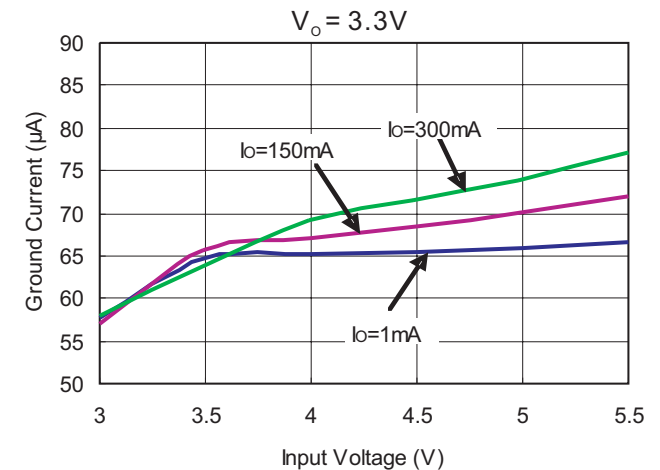
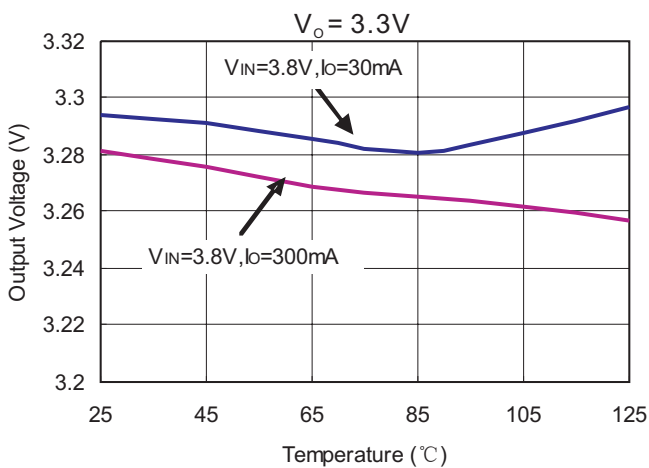
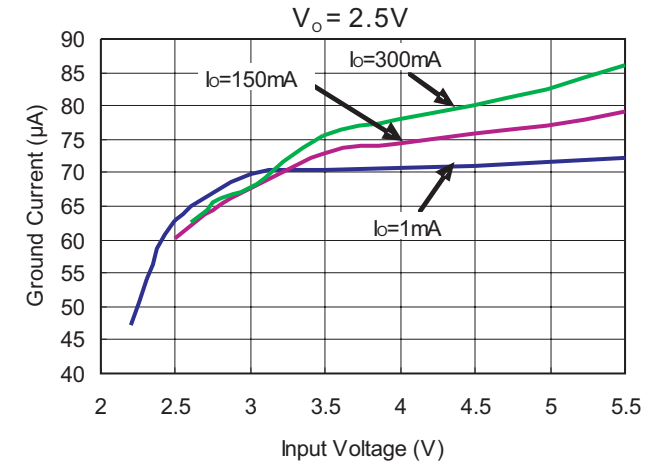
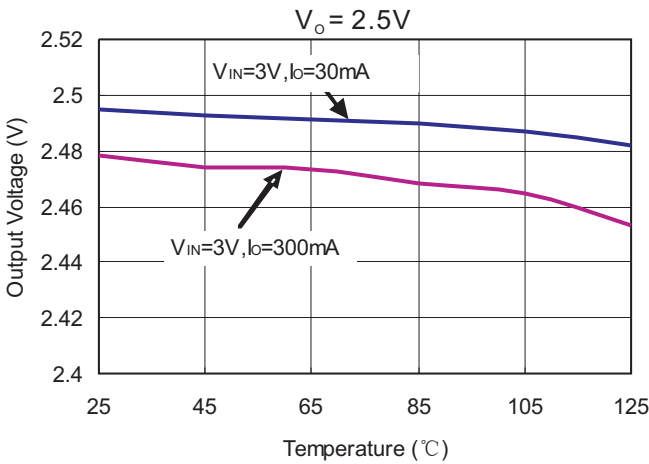
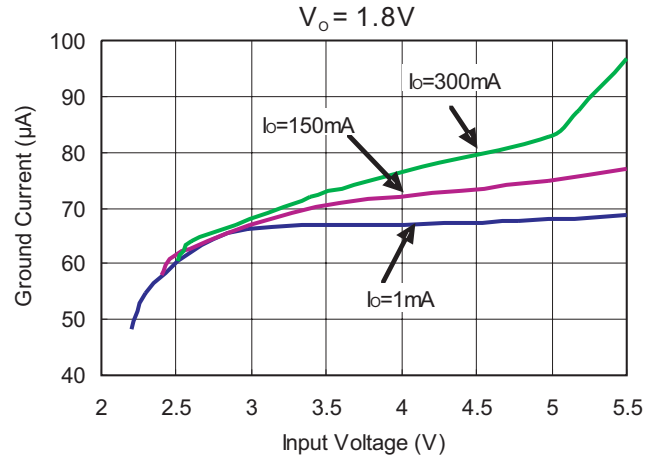

Typical Performance Characteristics

5. Dropout Voltage vs Output Current

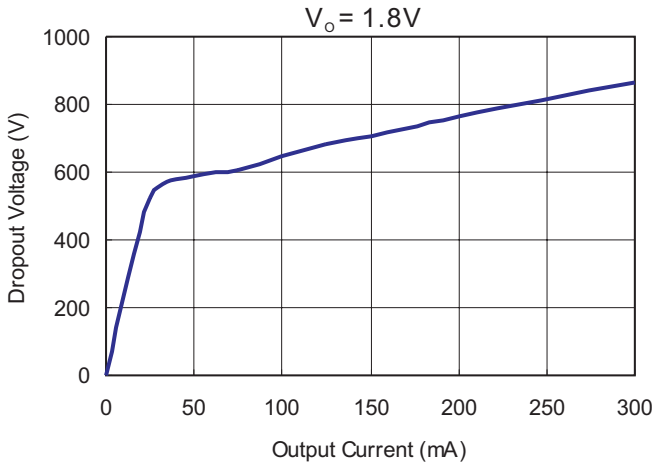

6. Dropout Voltage vs Temperature

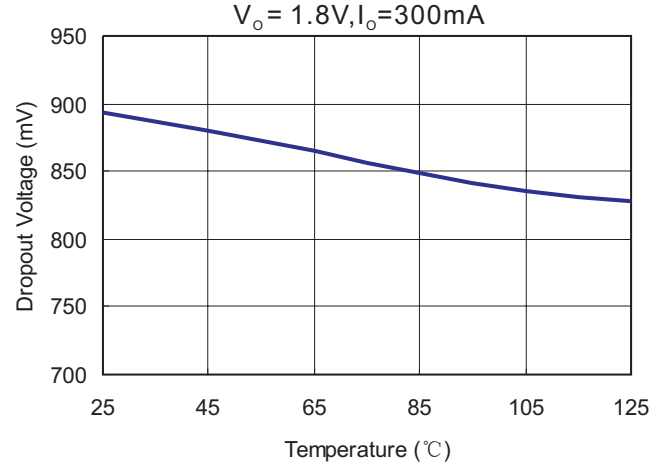

$V_o = 2.5V$

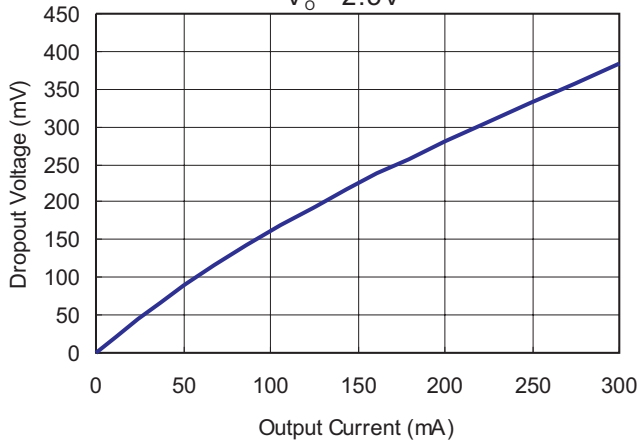

$V_o = 2.5V, I_o = 300mA$

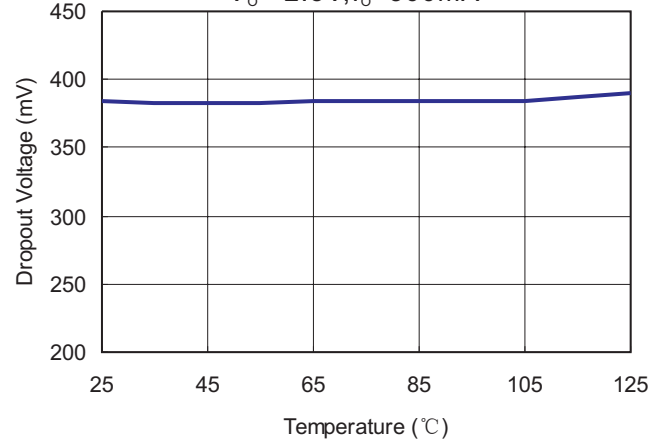

$V_o = 3.3V$

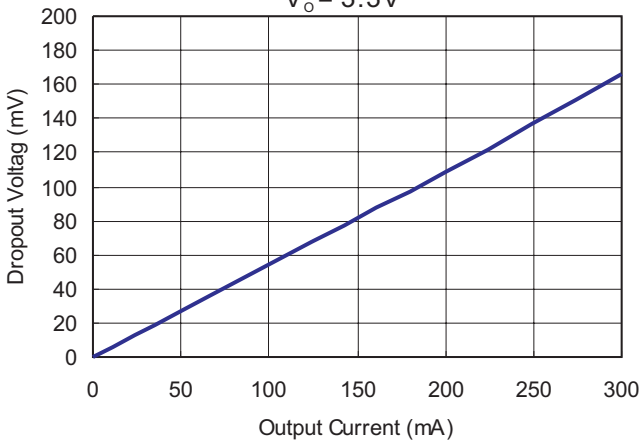

$V_o = 3.3V, I_o = 300mA$

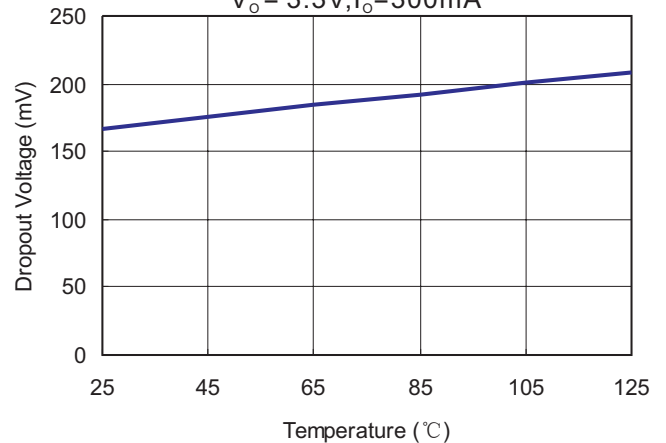

Typical Performance Characteristics (continued)

7. Quiescent Current vs Input Voltage
 $V_o = 1.8V$

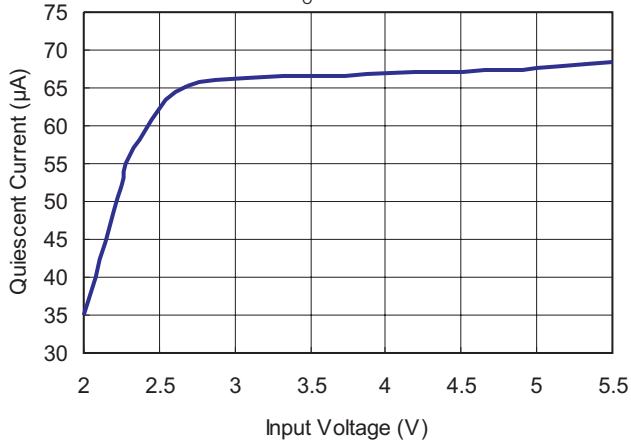

8. Quiescent Current vs Temperature
 $V_o = 1.8V$

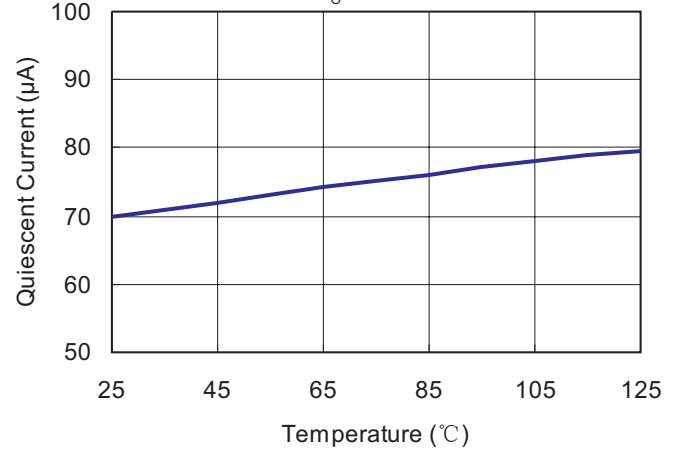

$V_o = 2.5V$

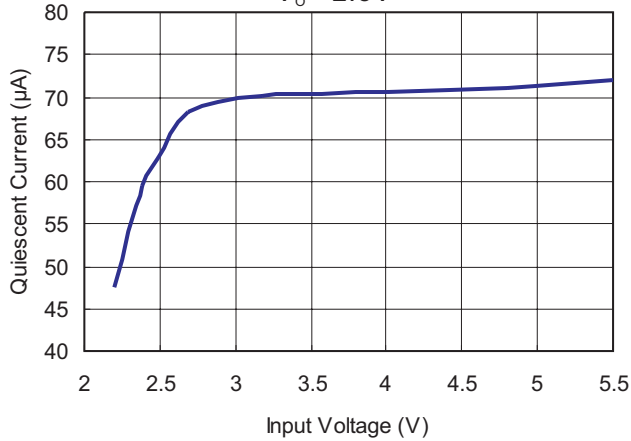

$V_o = 2.5V$

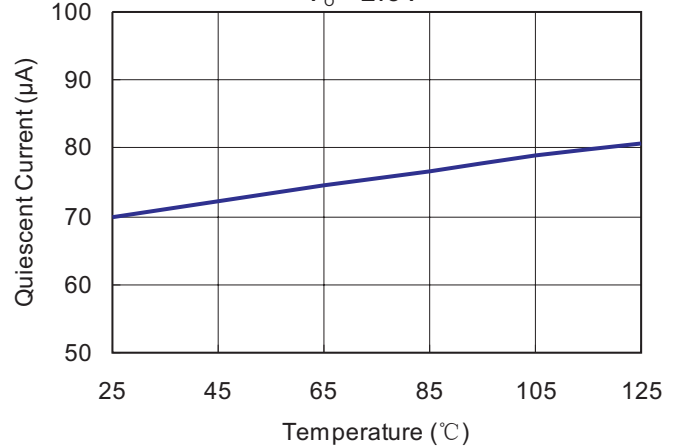

$V_o = 3.3V$

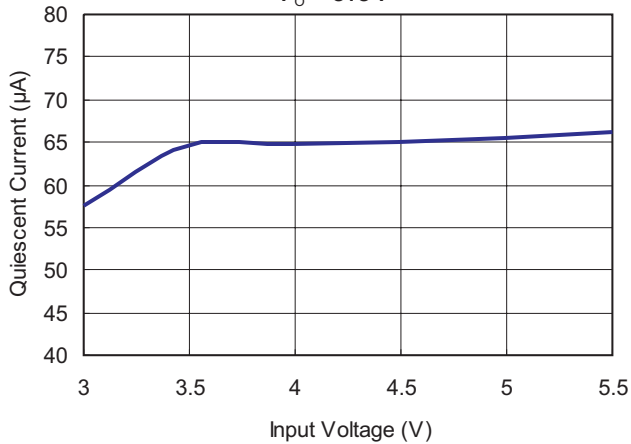

$V_o = 3.3V$

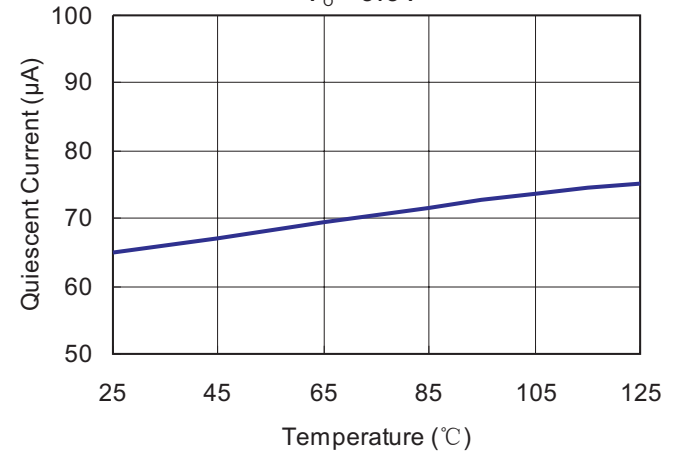

Typical Performance Characteristics

9. Power Supply Ripple Rejection

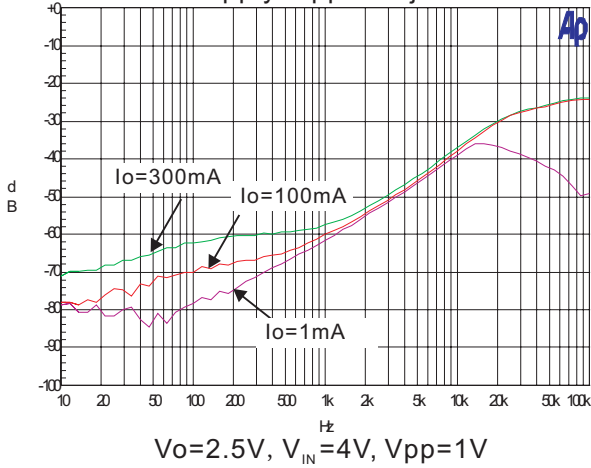

10. Load Transient Response

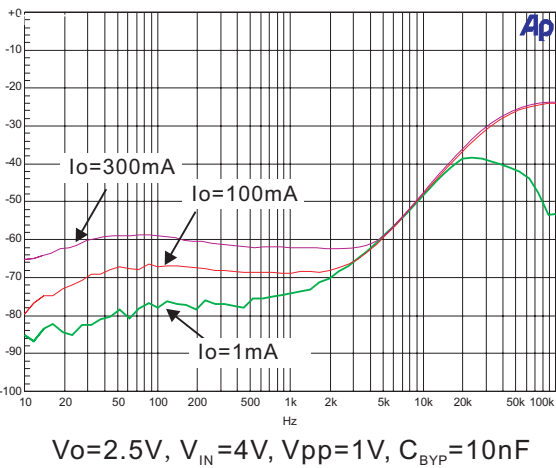
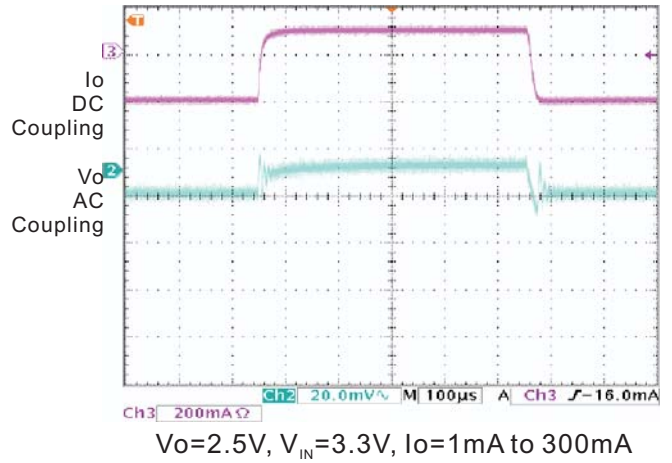

11. Line Transient Response

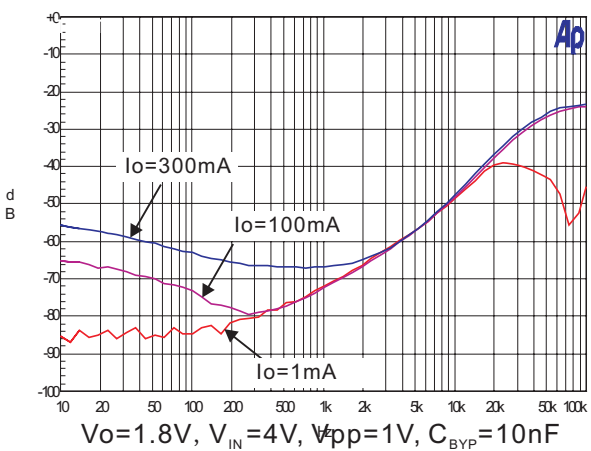
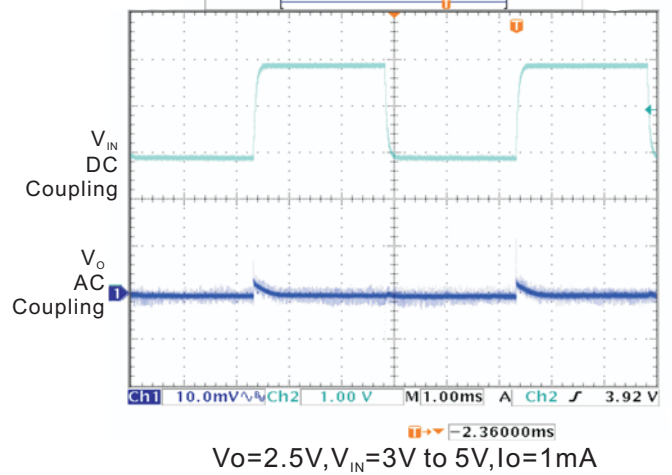

12. Turn-on Response

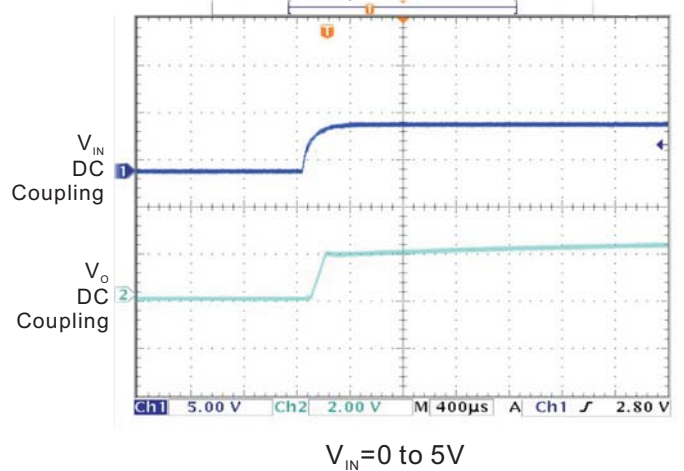

Typical Performance Characteristics

13. PSRR vs V-dropout@Vout=3.28V

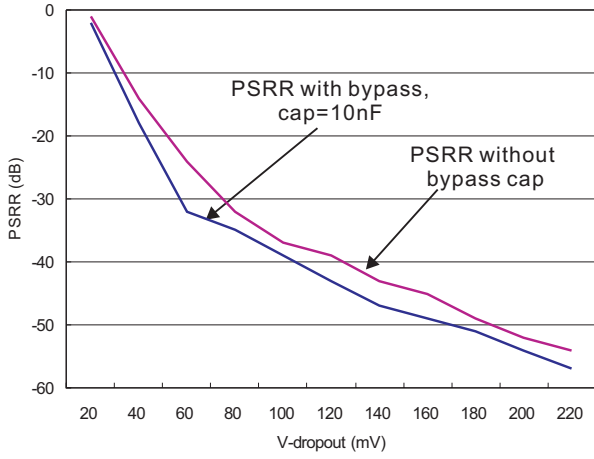

14. Noise

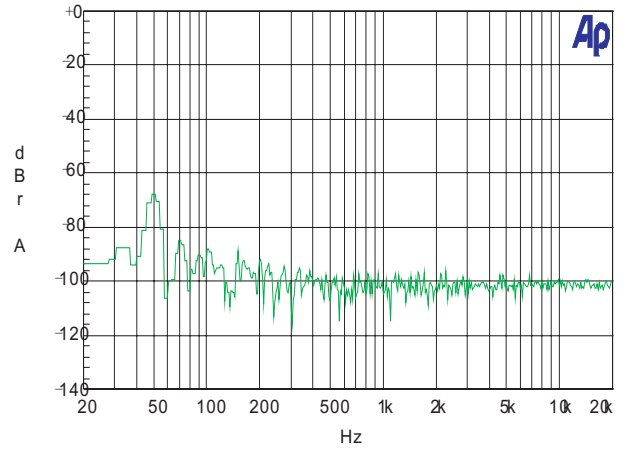



Application Information

Capacitor Selection and Regulator Stability

Similar to any low dropout regulator, the external capacitors used with the PAM3101 must be carefully selected for regulator stability and performance.

A capacitor C_{IN} of more than $1\mu\text{F}$ can be employed in the input pin, while there is no upper limit for the capacitance of C_{IN} . Please note that the distance between C_{IN} and the input pin of the PAM3101 should not exceed 0.5 inch. Ceramic capacitors are suitable for the PAM3101. Capacitors with larger values and lower ESR (equivalent series resistance) provide better PSRR and line-transient response.

The PAM3101 is designed specifically to work with low ESR ceramic output capacitors in order to save space and improve performance. Using an output ceramic capacitor whose value is $>2.2\mu\text{F}$ with $\text{ESR} > 5\text{m}\Omega$ ensures stability.

A 10nF bypass capacitor connected to BYP pin is suggested for suppressing output noise. The capacitor, in series connection with an internal 200k Ω resistor, forms a low-pass filter for noise reduction. Increasing the capacitance will slightly decrease the output noise, but increase the start-up time.

Load Transient Considerations

Curve 10 of the PAM3101 load-transient response on page 10 shows two components of the output response: a DC shift from the output impedance due to the load current change and transient response. The DC shift is quite small due to excellent load regulation of the PAM3101. The transient spike, resulting from a step change

in the load current from 1mA to 300mA, is 20mV. The ESR of the output capacitor is critical to the transient spike. A larger capacitance along with smaller ESR results in a smaller spike.

Shutdown Input Operation

The PAM3101 is shut down by pulling the EN input low, and is turned on by tying the EN input to VIN or leaving the EN input floating.

Internal P-Channel Pass Transistor

The PAM3101 features a 0.75 Ω P-Channel MOSFET device as a pass transistor. The P-MOS pass transistor enables the PAM3101 to consume only 65 μA of ground current during low dropout, light-load, or heavy-load operations. This feature increases the battery operation life time.

Input-Output (Dropout) Voltage

A regulator's minimum input-output voltage difference (or dropout voltage) determines the lowest usable supply voltage. The PAM3101 has a typical 300mV dropout voltage. In battery-powered systems, this will determine the useful end-of-life battery voltage.

Current Limit and Short Circuit Protection

The PAM3101 features a current limit, which monitors and controls the gate voltage of the pass transistor. The output current can be limited to 400mA by regulating the gate voltage. The PAM3101 also has a built-in short circuit current limit.



Thermal considerations

Thermal protection limits power dissipation in the PAM3101. When the junction temperature exceeds 150°C, the OTP (Over Temperature Protection) starts the thermal shutdown and turns the pass transistor off. The pass transistor resumes operation after the junction temperature drops below 120°C.

For continuous operation, the junction temperature should be maintained below 125°C. The power dissipation is defined as:

$$P_D = (V_{IN} - V_{OUT}) * I_O + V_{IN} * I_{GND}$$

The maximum power dissipation depends on the thermal resistance of IC package, PCB layout, the rate of surrounding airflow and temperature difference between junction and ambient. The maximum power dissipation can be calculated by the following formula:

$$P_{D(MAX)} = (T_{J(MAX)} - T_A) / \theta_{JA}$$

Where $T_{J(MAX)}$ is the maximum allowable junction temperature 125°C, T_A is the ambient temperature and θ_{JA} is the thermal resistance from the junction to the ambient.

For example, as θ_{JA} is 250°C/W for the SOT-23 package and 180°C/W for the SOT-89 package

based on the standard JEDEC 51-3 for a single-layer thermal test board, the maximum power dissipation at $T_A=25^\circ\text{C}$ can be calculated by following formula:

$$P_{D(MAX)} = (125^\circ\text{C} - 25^\circ\text{C}) / 250 = 0.4\text{W} \quad \text{SOT-23}$$

$$P_{D(MAX)} = (125^\circ\text{C} - 25^\circ\text{C}) / 180 = 0.55\text{W} \quad \text{SOT-89}$$

It is also useful to calculate the junction temperature of the PAM3101 under a set of specific conditions. For example, suppose the input voltage $V_{IN}=3.3\text{V}$, the output current $I_O=300\text{mA}$ and the case temperature $T_A=40^\circ\text{C}$ measured by a thermocouple during operation, the power dissipation for the $V_O=2.8\text{V}$ version of the PAM3101 can be calculated as:

$$P_D = (3.3\text{V} - 2.8\text{V}) * 300\text{mA} + 3.3\text{V} * 70\mu\text{A} \cong 150\text{mW}$$

And the junction temperature, T_J , can be calculated as follows:

$$T_J = T_A + P_D * \theta_{JA}$$

$$T_J = 40^\circ\text{C} + 0.15\text{W} * 250^\circ\text{C/W}$$

$$= 40^\circ\text{C} + 37.5^\circ\text{C}$$

$$= 77.5^\circ\text{C} < T_{J(MAX)} = 125^\circ\text{C}$$

For this operating condition, T_J is lower than the absolute maximum operating junction temperature, 125°C, so it is safe to use the PAM3101 in this configuration.



Ordering Information

PAM3101 X X X xxx

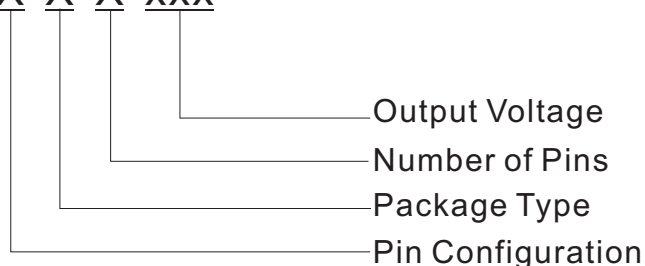

Pin Configuration		Package Type	Number of Pins	Output Voltage
A Type	E Type	A: SOT-23	A: 3	475: 4.75V
1. GND	1. VOUT	C: SOT-89	K: 4	400: 4.0V
2. VOUT	2. GND	U: SC70	B: 5	380: 3.8V
3. VIN	3. NC			330: 3.3V
C Type	4. EN			310: 3.1V
1. VOUT	5. VIN			300: 3.0V
2. GND	F Type			290: 2.9V
3. VIN	1. EN			285: 2.85V
D Type	2. GND			280: 2.8V
1. VIN	3. VOUT			250: 2.5V
2. GND	4. VIN			180: 1.8V
3. EN	H Type			150: 1.5V
4. BYP	1. GND			
5. VOUT	2. VIN			
	3. VOUT			
	G Type			
	1. VIN			
	2. VOUT			
	3. GND			



Ordering Information (continued)

Part Number	Output Voltage	Marking	Package Type	Shipping Package
PAM3101AAA475	4.75V	AATYW	SOT23-3	3,000Units/Tape&Reel
PAM3101AAA400	4.0V	AAMYW	SOT23-3	3,000Units/Tape&Reel
PAM3101AAA380	3.8V	AAOYW	SOT23-3	3,000Units/Tape&Reel
PAM3101AAA330	3.3V	AAKYW	SOT23-3	3,000Units/Tape&Reel
PAM3101AAA310	3.1V	AAPYW	SOT23-3	3,000Units/Tape&Reel
PAM3101AAA300	3.0V	AAJYW	SOT23-3	3,000Units/Tape&Reel
PAM3101AAA290	2.9V	AAQYW	SOT23-3	3,000Units/Tape&Reel
PAM3101AAA285	2.85V	AAIYW	SOT23-3	3,000Units/Tape&Reel
PAM3101AAA280	2.8V	AAHYW	SOT23-3	3,000Units/Tape&Reel
PAM3101AAA250	2.5V	AAGYW	SOT23-3	3,000Units/Tape&Reel
PAM3101AAA180	1.8V	AAEYW	SOT23-3	3,000Units/Tape&Reel
PAM3101AAA150	1.5V	AACYW	SOT23-3	3,000Units/Tape&Reel
PAM3101GAA475	4.75V	AATYW	SOT23-3	3,000Units/Tape&Reel
PAM3101GAA400	4.0V	AAMYW	SOT23-3	3,000Units/Tape&Reel
PAM3101GAA380	3.8V	AAOYW	SOT23-3	3,000Units/Tape&Reel
PAM3101GAA330	3.3V	AAKYW	SOT23-3	3,000Units/Tape&Reel
PAM3101GAA310	3.1V	AAPYW	SOT23-3	3,000Units/Tape&Reel
PAM3101GAA300	3.0V	AAJYW	SOT23-3	3,000Units/Tape&Reel
PAM3101GAA290	2.9V	AAQYW	SOT23-3	3,000Units/Tape&Reel
PAM3101GAA285	2.85V	AAIYW	SOT23-3	3,000Units/Tape&Reel
PAM3101GAA280	2.8V	AAHYW	SOT23-3	3,000Units/Tape&Reel
PAM3101GAA250	2.5V	AAGYW	SOT23-3	3,000Units/Tape&Reel
PAM3101GAA180	1.8V	AAEYW	SOT23-3	3,000Units/Tape&Reel
PAM3101GAA150	1.5V	AACYW	SOT23-3	3,000Units/Tape&Reel
PAM3101CAA475	4.75V	AATYW	SOT23-3	3,000Units/Tape&Reel
PAM3101CAA400	4.0V	AAMYW	SOT23-3	3,000Units/Tape&Reel
PAM3101CAA380	3.8V	AAOYW	SOT23-3	3,000Units/Tape&Reel
PAM3101CAA330	3.3V	AAKYW	SOT23-3	3,000Units/Tape&Reel
PAM3101CAA310	3.1V	AAPYW	SOT23-3	3,000Units/Tape&Reel
PAM3101CAA300	3.0V	AAJYW	SOT23-3	3,000Units/Tape&Reel
PAM3101CAA290	2.9V	AAQYW	SOT23-3	3,000Units/Tape&Reel
PAM3101CAA285	2.85V	AAIYW	SOT23-3	3,000Units/Tape&Reel
PAM3101CAA280	2.8V	AAHYW	SOT23-3	3,000Units/Tape&Reel
PAM3101CAA250	2.5V	AAGYW	SOT23-3	3,000Units/Tape&Reel
PAM3101CAA180	1.8V	AAEYW	SOT23-3	3,000Units/Tape&Reel
PAM3101CAA150	1.5V	AACYW	SOT23-3	3,000Units/Tape&Reel



Ordering Information(continued)

Part Number	Output Voltage	Marking	Package Type	Shipping Package
PAM3101CCA475	4.75V	P3101T XXXYW	SOT89-3	1,000Units/Tape&Reel
PAM3101CCA400	4.0V	P3101M XXXYW	SOT89-3	1,000Units/Tape&Reel
PAM3101CCA380	3.8V	P3101O XXXYW	SOT89-3	1,000Units/Tape&Reel
PAM3101CCA330	3.3V	P3101K XXXYW	SOT89-3	1,000Units/Tape&Reel
PAM3101CCA310	3.1V	P3101P XXXYW	SOT89-3	1,000Units/Tape&Reel
PAM3101CCA300	3.0V	P3101J XXXYW	SOT89-3	1,000Units/Tape&Reel
PAM3101CCA290	2.9V	P3101Q XXXYW	SOT89-3	1,000Units/Tape&Reel
PAM3101CCA285	2.85V	P3101I XXXYW	SOT89-3	1,000Units/Tape&Reel
PAM3101CCA280	2.8V	P3101H XXXYW	SOT89-3	1,000Units/Tape&Reel
PAM3101CCA250	2.5V	P3101G XXXYW	SOT89-3	1,000Units/Tape&Reel
PAM3101CCA180	1.8V	P3101E XXXYW	SOT89-3	1,000Units/Tape&Reel
PAM3101CCA150	1.5V	P3101C XXXYW	SOT89-3	1,000Units/Tape&Reel
PAM3101HCA475	4.75V	P3101T XXXYW	SOT89-3	1,000Units/Tape&Reel
PAM3101HCA400	4.0V	P3101M XXXYW	SOT89-3	1,000Units/Tape&Reel
PAM3101HCA380	3.8V	P3101O XXXYW	SOT89-3	1,000Units/Tape&Reel
PAM3101HCA330	3.3V	P3101K XXXYW	SOT89-3	1,000Units/Tape&Reel
PAM3101HCA310	3.1V	P3101P XXXYW	SOT89-3	1,000Units/Tape&Reel
PAM3101HCA300	3.0V	P3101J XXXYW	SOT89-3	1,000Units/Tape&Reel
PAM3101HCA290	2.90V	P3101Q XXXYW	SOT89-3	1,000Units/Tape&Reel
PAM3101HCA285	2.85V	P3101I XXXYW	SOT89-3	1,000Units/Tape&Reel
PAM3101HCA280	2.8V	P3101H XXXYW	SOT89-3	1,000Units/Tape&Reel



PAM3101

300mA High PSRR Low Dropout CMOS Linear Regulator

Ordering Information(continued)

Part Number	Output Voltage	Marking	Package Type	Shipping Package
PAM3101HCA250	2.5V	P3101G XXXYW	SOT89-3	1,000Units/Tape&Reel
PAM3101HCA180	1.8V	P3101E XXXYW	SOT89-3	1,000Units/Tape&Reel
PAM3101HCA150	1.5V	P3101C XXXYW	SOT89-3	1,000Units/Tape&Reel
PAM3101DBA475	4.75V	AATYW	SOT23-5	3,000Units/Tape&Reel
PAM3101DBA400	4.0V	AAMYW	SOT23-5	3,000Units/Tape&Reel
PAM3101DAB380	3.8V	AAOYW	SOT23-5	3,000Units/Tape&Reel
PAM3101DAB330	3.3V	AAKYW	SOT23-5	3,000Units/Tape&Reel
PAM3101DAB310	3.1V	AAPYW	SOT23-5	3,000Units/Tape&Reel
PAM3101DAB300	3.0V	AAJYW	SOT23-5	3,000Units/Tape&Reel
PAM3101DAB290	2.9V	AAQYW	SOT23-5	3,000Units/Tape&Reel
PAM3101DAB285	2.85V	AAIYW	SOT23-5	3,000Units/Tape&Reel
PAM3101DAB280	2.8V	AAHYW	SOT23-5	3,000Units/Tape&Reel
PAM3101DAB250	2.5V	AAGYW	SOT23-5	3,000Units/Tape&Reel
PAM3101DAB180	1.8V	AAEYW	SOT23-5	3,000Units/Tape&Reel
PAM3101DAB150	1.5V	AACYW	SOT23-5	3,000Units/Tape&Reel
PAM3101ECB475	4.75V	P3101T XXXYW	SOT89-5	1,000Units/Tape&Reel
PAM3101ECB400	4.0V	P3101M XXXYW	SOT89-5	1,000Units/Tape&Reel
PAM3101ECB380	3.8V	P3101O XXXYW	SOT89-5	1,000Units/Tape&Reel
PAM3101ECB330	3.3V	P3101K XXXYW	SOT89-5	1,000Units/Tape&Reel
PAM3101ECB310	3.1V	P3101P XXXYW	SOT89-5	1,000Units/Tape&Reel
PAM3101ECB300	3.0V	P3101J XXXYW	SOT89-5	1,000Units/Tape&Reel
PAM3101ECB290	2.9V	P3101Q XXXYW	SOT89-5	1,000Units/Tape&Reel
PAM3101ECB285	2.85V	P3101I XXXYW	SOT89-5	1,000Units/Tape&Reel
PAM3101ECB280	2.8V	P3101H XXXYW	SOT89-5	1,000Units/Tape&Reel
PAM3101ECB250	2.5V	P3101G XXXYW	SOT89-5	1,000Units/Tape&Reel
PAM3101ECB180	1.8V	P3101E XXXYW	SOT89-5	1,000Units/Tape&Reel
PAM3101ECB150	1.5V	P3101C XXXYW	SOT89-5	1,000Units/Tape&Reel

Power Analog Microelectronics, Inc



Ordering Information

Part Number	Output Voltage	Marking	Package Type	Shipping Package
PAM3101GUA475	4.75V	AATYW	SC70-3L	3,000Units/Tape&Reel
PAM3101GUA400	4.0V	AAMYW	SC70-3L	3,000Units/Tape&Reel
PAM3101GUA380	3.8V	AAOYW	SC70-3L	3,000Units/Tape&Reel
PAM3101GUA330	3.3V	AAKYW	SC70-3L	3,000Units/Tape&Reel
PAM3101GUA310	3.1V	AAPYW	SC70-3L	3,000Units/Tape&Reel
PAM3101GUA300	3.0V	AAJYW	SC70-3L	3,000Units/Tape&Reel
PAM3101GUA290	2.9V	AAQYW	SC70-3L	3,000Units/Tape&Reel
PAM3101GUA285	2.85V	AAIYW	SC70-3L	3,000Units/Tape&Reel
PAM3101GUA280	2.8V	AAHYW	SC70-3L	3,000Units/Tape&Reel
PAM3101GUA250	2.5V	AAGYW	SC70-3L	3,000Units/Tape&Reel
PAM3101GUA180	1.8V	AAEYW	SC70-3L	3,000Units/Tape&Reel
PAM3101GUA150	1.5V	AACYW	SC70-3L	3,000Units/Tape&Reel
PAM3101FUK475	4.75V	AATYW	SC70-4L	3,000Units/Tape&Reel
PAM3101FUK400	4.0V	AAMYW	SC70-4L	3,000Units/Tape&Reel
PAM3101FUK380	3.8V	AAOYW	SC70-4L	3,000Units/Tape&Reel
PAM3101FUK330	3.3V	AAKYW	SC70-4L	3,000Units/Tape&Reel
PAM3101FUK310	3.1V	AAPYW	SC70-4L	3,000Units/Tape&Reel
PAM3101FUK300	3.0V	AAJYW	SC70-4L	3,000Units/Tape&Reel
PAM3101FUK290	2.9V	AAQYW	SC70-4L	3,000Units/Tape&Reel
PAM3101FUK285	2.85V	AAIYW	SC70-4L	3,000Units/Tape&Reel
PAM3101FUK280	2.8V	AAHYW	SC70-4L	3,000Units/Tape&Reel
PAM3101FUK250	2.5V	AAGYW	SC70-4L	3,000Units/Tape&Reel
PAM3101FUK180	1.8V	AAEYW	SC70-4L	3,000Units/Tape&Reel
PAM3101FUK150	1.5V	AACYW	SC70-4L	3,000Units/Tape&Reel
PAM3101DUB475	4.75V	AATYW	SC70-5L	3,000Units/Tape&Reel
PAM3101DUB400	4.0V	AAMYW	SC70-5L	3,000Units/Tape&Reel
PAM3101DUB380	3.8V	AAOYW	SC70-5L	3,000Units/Tape&Reel
PAM3101DUB330	3.3V	AAKYW	SC70-5L	3,000Units/Tape&Reel
PAM3101DUB310	3.1V	AAPYW	SC70-5L	3,000Units/Tape&Reel
PAM3101DUB300	3.0V	AAJYW	SC70-5L	3,000Units/Tape&Reel
PAM3101DUB290	2.9V	AAQYW	SC70-5L	3,000Units/Tape&Reel
PAM3101DUB285	2.85V	AAIYW	SC70-5L	3,000Units/Tape&Reel
PAM3101DUB280	2.8V	AAHYW	SC70-5L	3,000Units/Tape&Reel
PAM3101DUB250	2.5V	AAGYW	SC70-5L	3,000Units/Tape&Reel
PAM3101DUB180	1.8V	AAEYW	SC70-5L	3,000Units/Tape&Reel
PAM3101DUB150	1.5V	AACYW	SC70-5L	3,000Units/Tape&Reel

Outline Dimension

SOT23-3

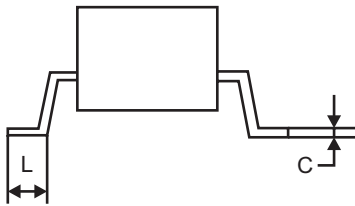
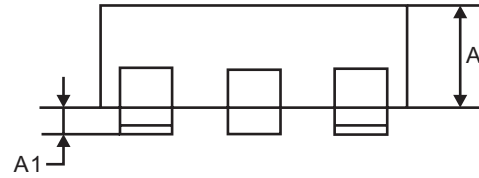
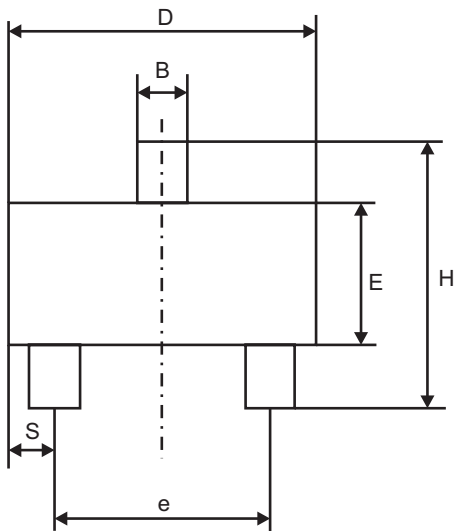

Dim	Millimeters		
	Min.	Typ.	Max.
A	1.00	1.15	1.30
A1	0.00	0.05	0.10
B	0.35	0.43	0.51
C	0.10	0.175	0.25
D	2.70	2.90	3.10
E	1.40	1.60	1.80
e	1.90BSC		
H	2.40	2.70	3.00
L	0.37		

Outline Dimension

SOT23-5

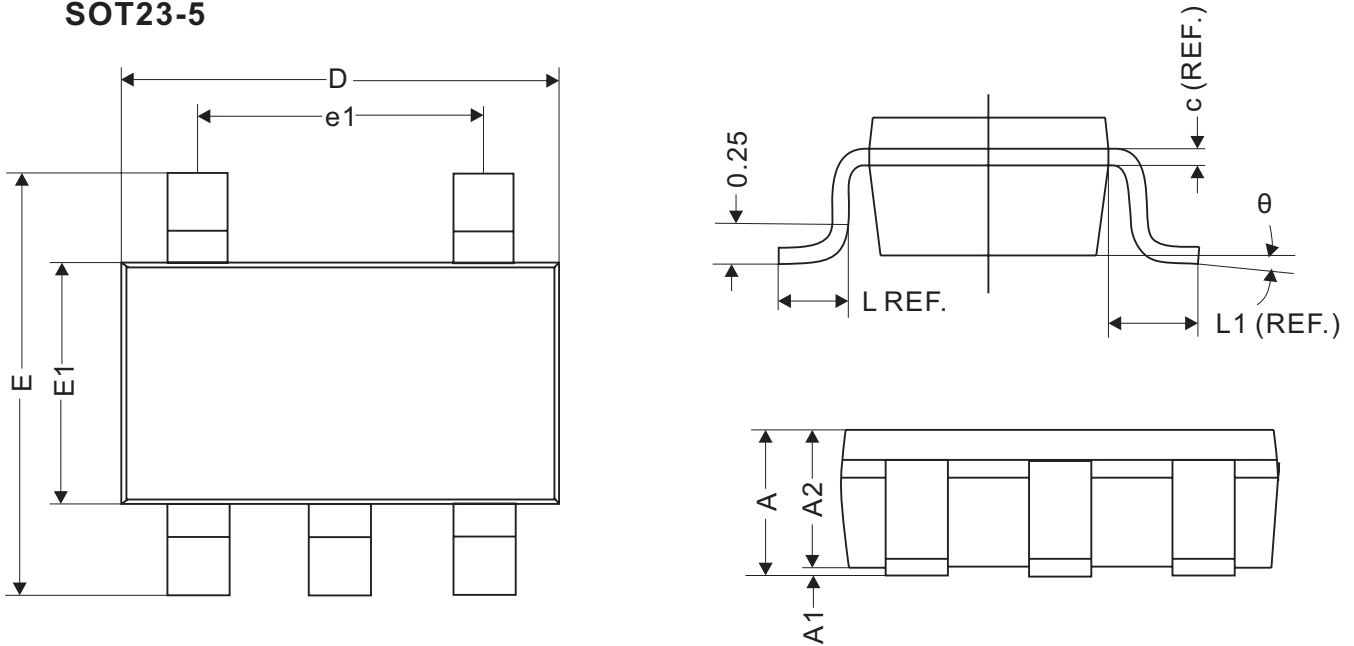

REF.	Millimeter		
	Min	Nom	Max
A	1.10MAX		
A1	0	0.05	0.10
A2	0.70	1.00	1.295
c	0.12REF.		
D	2.70	2.90	3.10
E	2.60	2.80	3.00
E1	1.40	1.60	1.80
L	0.45REF.		
L1	0.60REF.		
θ	0°	5°	10°
b	0.30	0.40	0.50
e	0.95REF.		
e1	1.90REF.		

Outline Dimension

SOT89-3

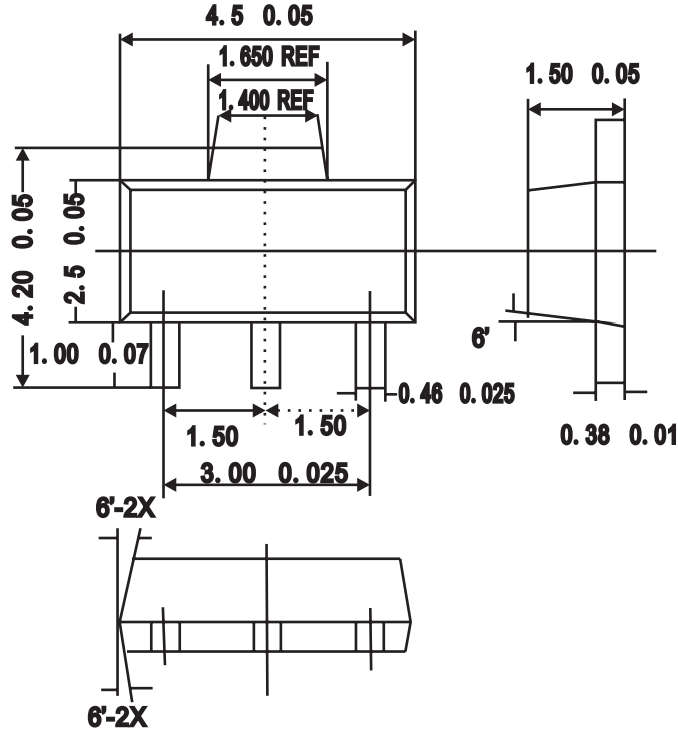

(Unit: mm)

SOT89-5

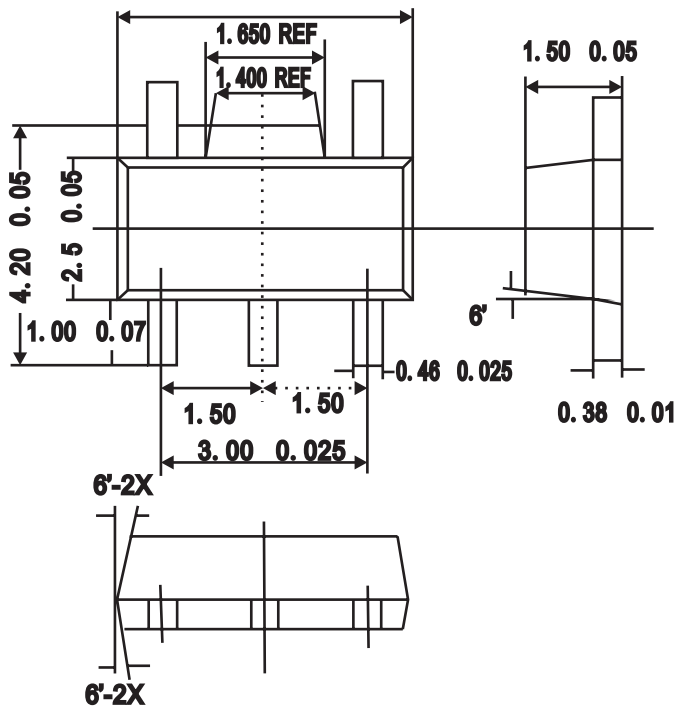

(Unit: mm)

Outline Dimension

SC70-4L

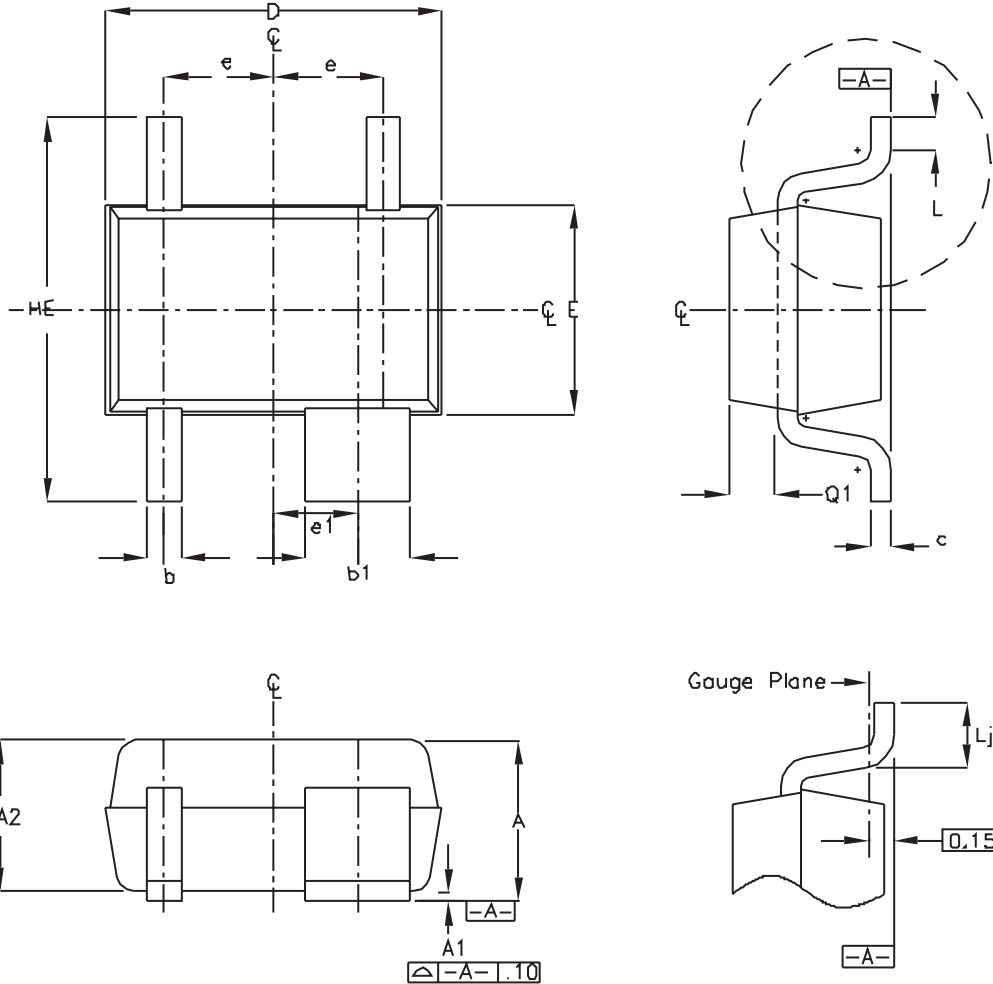

SYMBOL	MIN	MAX
e	0.65 BSC	
e_1	0.50 BSC	
D	1.80	2.20
b	0.15	0.30
b_1	0.575	0.700
E	1.15	1.35
HE	1.80	2.40
$Q1$	0.10	0.40
A_2	0.80	1.00
A_1	0.00	0.10
A	0.80	1.10
c	0.10	0.30
L	0.10	0.30
L_j	0.26	0.46

- 1) ALL DIMENSIONS ARE IN MILLIMETERS
- 2) DIMENSIONS ARE INCLUSIVE OF PLATING
- 3) DIMENSIONS ARE EXCLUSIVE OF MOLD FLASH & METAL BURR
- 4) CUSTOM LEADCOUNT VARIATION OF JEITA SC70

Outline Dimension

SC70-5L

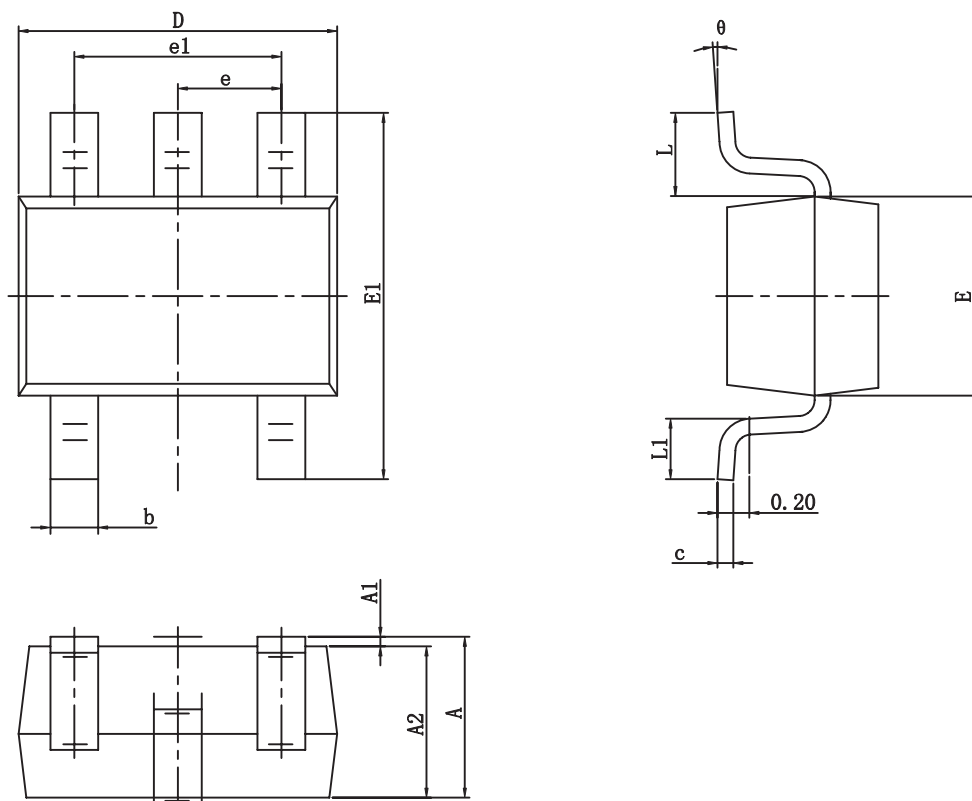

Symbol	Dimensions In Millimeters		Dimensions In Inches	
	Min	Max	Min	Max
A	0.900	1.100	0.035	0.043
A1	0.000	0.100	0.000	0.004
A2	0.900	1.000	0.035	0.039
b	0.150	0.350	0.006	0.014
c	0.080	0.150	0.003	0.006
D	2.000	2.200	0.079	0.087
E	1.150	1.350	0.045	0.053
E1	2.150	2.450	0.085	0.096
e	0.650 TYP		0.026 TYP	
e1	1.200	1.400	0.047	0.055
L	0.525 REF		0.021 REF	
L1	0.260	0.460	0.010	0.018
θ	0	8	0	8